

Pcb Sample
(Not Included)

KESIT A-A

PROPRIETARY AND CONFIDENTIAL THE INFORMATION CONTAINED IN THIS DRAWING IS THE SOLE PROPERTY OF ALTINKAYA ENCLOSURES. ANY REPRODUCTION IN PART OR AS A WHOLE WITHOUT THE WRITTEN PERMISSION OF ALTINKAYA ENCLOSURES IS PROHIBITED.		ARTICLE NO:	REVISION:
DRAWN: Dursun Daşdemir CHECKED: Ali Altınışık		 ALTINKAYA ENCLOSURES FOR ELECTRONICS	CONTACT: www.altinkaya.com.tr
COMMENTS: This drawing is subject to technical modification without prior notice. Typographical and other errors do not justify any claims for damages. All dimensions should be verified using an actual produced part.		TITLE:	
MATERIAL:		DWG NO: RM-201-0-0-S-0	A3
WEIGHT:		SCALE:1:2	SHEET OF

DIKKAT: BU RESİM VE ÜRÜN ÖNCEDEN
 HABER VERİLMEKSİZİN DEĞİŞTİREBİLİR.
 RESİM ÇİZİLMESİNİN HATASIZ OLMASINA
 ÇALIŞILMASINA RAĞMEN RESİMDE
 HATALAR BULUNABİLİR. RESİMDEKİ
 HATALARDAN DOLAYI OLUŞABİLECEK
 ZARARLAR İÇİN ALTINKAYA HIÇ BİR
 SORUMLULUK KABUL ETMEZ. BÜTÜN
 ÖLÇÜLER KULLANILMADAN ÖNCE
 ÜRETİLMİŞ GERÇEK NÜMUNEDEN
 KONTROL EDİLMELİDİR.

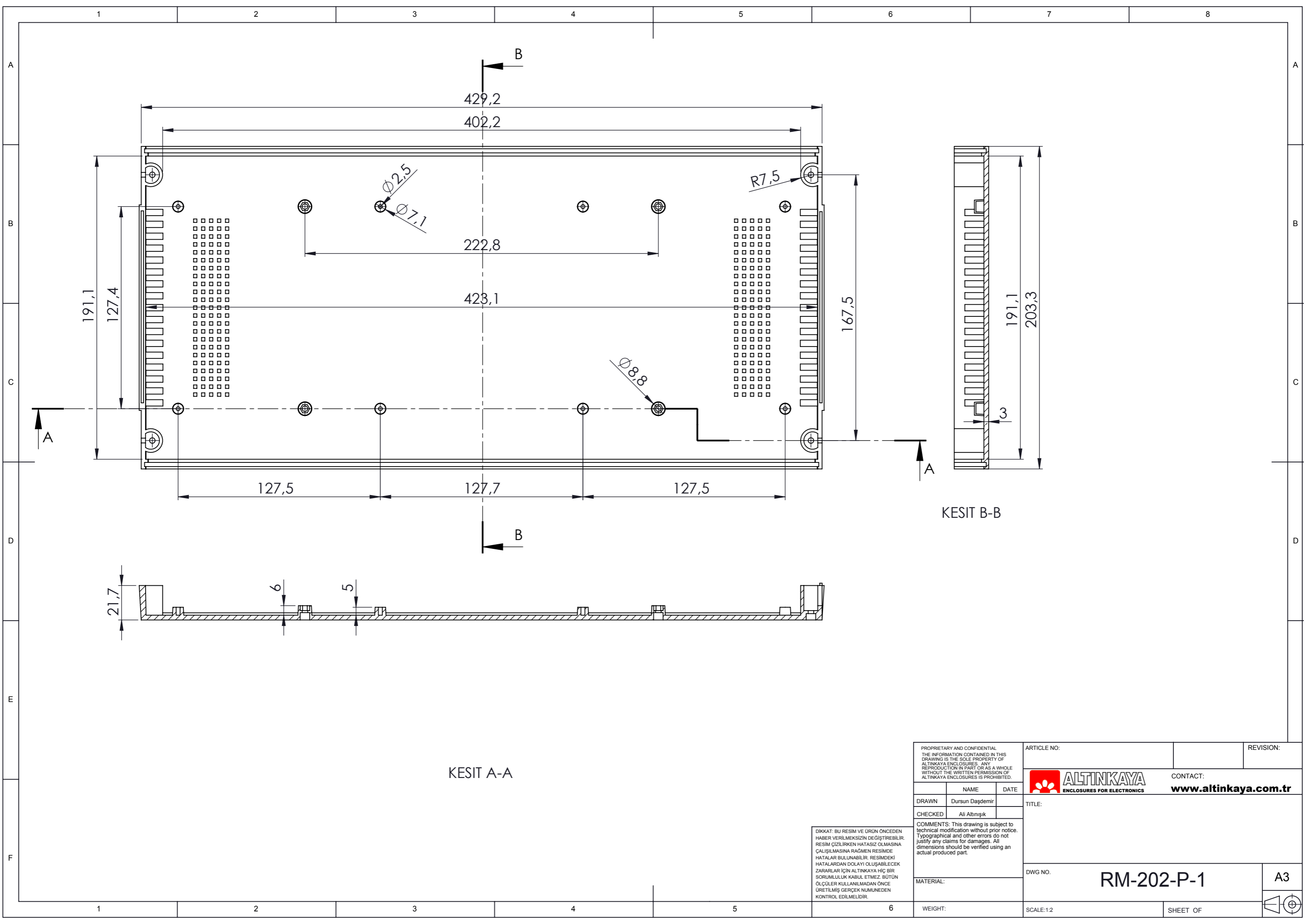

KESIT A-A

KESIT B-B

DIKKAT: BU RESİM VE ÜRÜN ÖNCEDEN HABER VERİLMEKSİZİN DEĞİŞTİREBİLİR. RESİM ÇİZİLİRKEN HATASIZ OLMASINA ÇALIŞILMASINA RAĞMEN RESİMDE HATALAR BULUNABİLİR. RESİMDEKİ HATALARDAN DOLAYI OLUŞABİLECEK ZARARLAR İÇİN ALTINKAYA HIÇ BİR SORUMLULUK KABUL ETMEZ. BÜTÜN ÖLÇÜLER KULLANILMADAN ÖNCE ÜRETİLMİŞ GERÇEK NÜMUNEDEN KONTROL EDİLMELİDİR.

PROPRIETARY AND CONFIDENTIAL. THE INFORMATION CONTAINED IN THIS DRAWING IS THE SOLE PROPERTY OF ALTINKAYA ENCLOSURES. ANY REPRODUCTION IN PART OR AS A WHOLE WITHOUT THE WRITTEN PERMISSION OF ALTINKAYA ENCLOSURES IS PROHIBITED.		ARTICLE NO:	REVISION:
DRAWN: Dursun Daşdemir CHECKED: Ali Altınışık		 CONTACT: www.altinkaya.com.tr	TITLE:
COMMENTS: This drawing is subject to technical modification without prior notice. Typographical and other errors do not justify any claims for damages. All dimensions should be verified using an actual produced part.		DWG NO: RM-202-P-1	A3
MATERIAL:		SCALE: 1:2	SHEET OF
WEIGHT:			

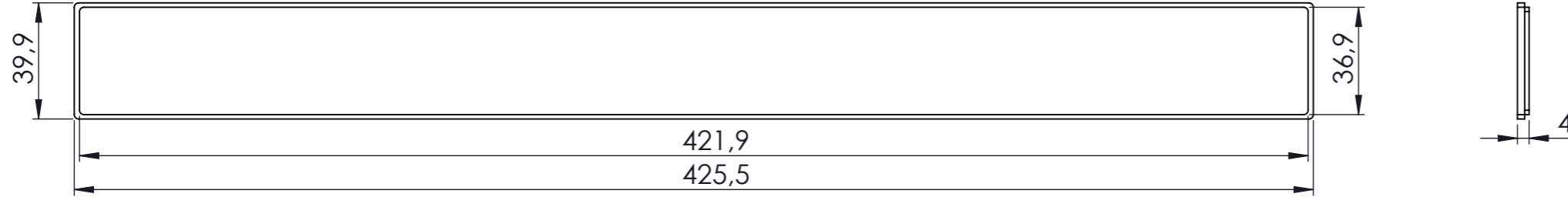

PROPRIETARY AND CONFIDENTIAL.
THE INFORMATION CONTAINED IN THIS
DRAWING IS THE SOLE PROPERTY OF
ALTINKAYA ENCLOSURES. ANY
REPRODUCTION IN PART OR AS A WHOLE
WITHOUT THE WRITTEN PERMISSION OF
ALTINKAYA ENCLOSURES IS PROHIBITED.

ARTICLE NO:

REVISION:

NAME	DATE
Dursun Daşdemir	



CONTACT:
www.altinkaya.com.tr

CHECKED	NAME	DATE
	Ali Altınışık	

TITLE:

COMMENTS: This drawing is subject to technical modification without prior notice. Typographical and other errors do not justify any claims for damages. All dimensions should be verified using an actual produced part.

Panel

MATERIAL:

DWG NO. **RM-201-P-2** A3

WEIGHT:

SCALE:1:2 SHEET OF

DIKKAT: BU RESİM VE ÜRÜN ÖNCEDEN HABER VERİLMEKSİZİN DEĞİŞTİREBİLİR. RESİM ÇİZİLİRKEN HATASIZ OLMASINA ÇALIŞILMASINA RAĞMEN RESİMDE HATALAR BULUNABİLİR. RESİMDEKİ HATALARDAN DOLAYI OLUŞABİLECEK ZARARLAR İÇİN ALTINKAYA HIÇ BİR SORUMLULUK KABUL ETMEZ. BÜTÜN ÖLÇÜLER KULLANILMADAN ÖNCE ÜRETİLMİŞ GERÇEK NÜMUNEDEN KONTROL EDİLMELİDİR.



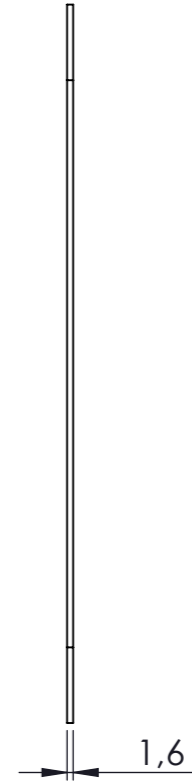
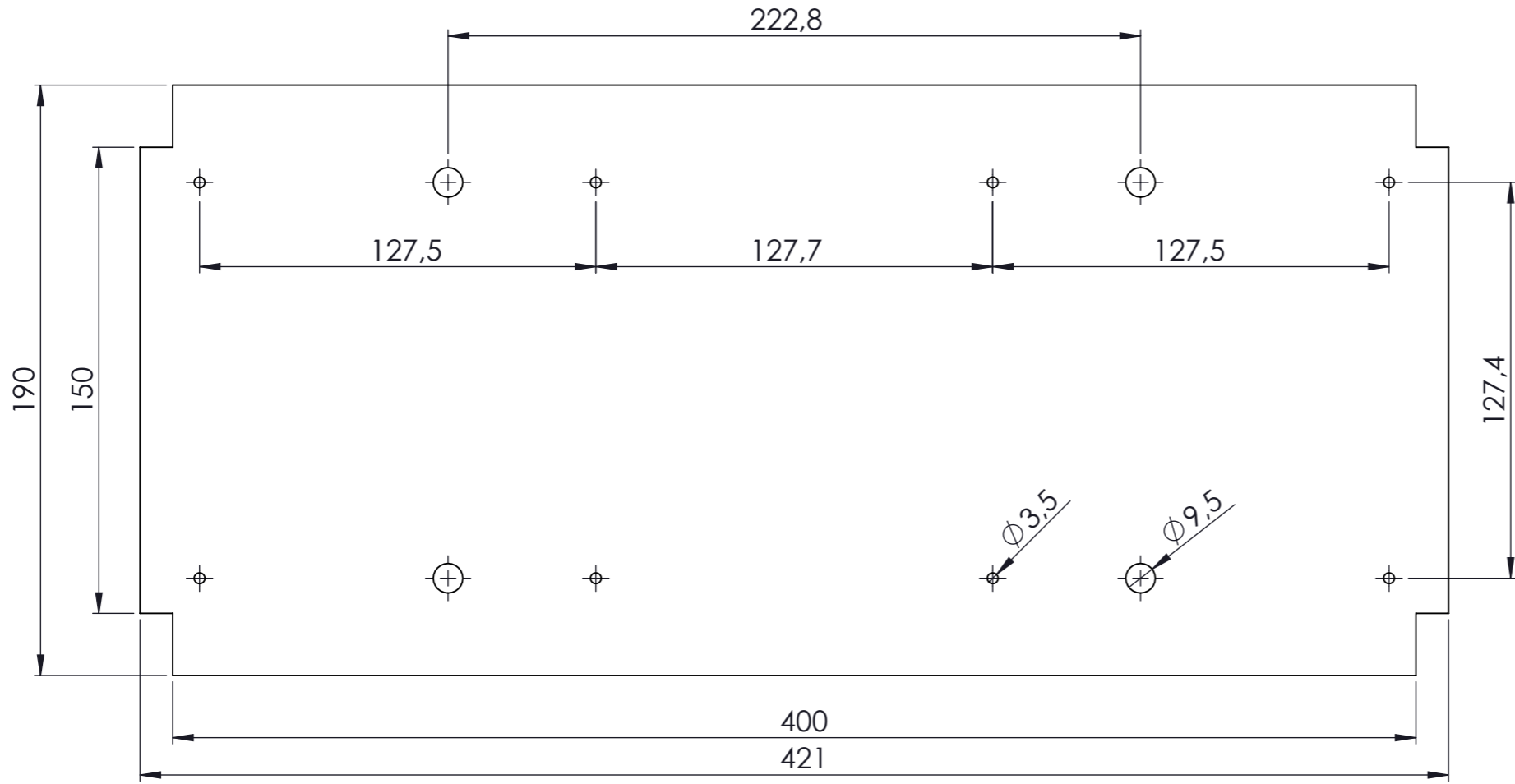

DIKKAT: BU RESİM VE ÜRÜN ÖNCEDEN HABER VERİLMEKSİZİN DEĞİŞTİREBİLİR. RESİM ÇİZİLMİŞ HATASIZ OLMASINA ÇALIŞILMASINA RAĞMEN RESİMDEKİ HATALAR BULUNABİLİR. RESİMDEKİ HATALARDAN DOLAYI OLUŞABİLECEK ZARARLAR İÇİN ALTINKAYA HIÇ BİR SORUMLULUK KABUL ETMEZ. BÜTÜN ÖLÇÜLER KULLANILMADAN ÖNCE ÜRETİLMİŞ GERÇEK NÜMUNEDEN KONTROL EDİLMELİDİR.

PROPRIETARY AND CONFIDENTIAL THE INFORMATION CONTAINED IN THIS DRAWING IS THE SOLE PROPERTY OF ALTINKAYA ENCLOSURES. ANY REPRODUCTION IN PART OR AS A WHOLE WITHOUT THE WRITTEN PERMISSION OF ALTINKAYA ENCLOSURES IS PROHIBITED.		ARTICLE NO:	REVISION:
DRAWN: Dursun Daşdemir CHECKED: Ali Altınışık		 ENCLOSURES FOR ELECTRONICS	CONTACT: www.altinkaya.com.tr
COMMENTS: This drawing is subject to technical modification without prior notice. Typographical and other errors do not justify any claims for damages. All dimensions should be verified using an actual produced part.		<h2>Pcb Sample Not Included</h2>	
MATERIAL:		DWG NO:	A3
WEIGHT:		SCALE:1:2	SHEET OF